

REVISIONS			
A	PR329	16-MAY-97	RJD

*** COMPONENT VALUES THAT DIFFER BETWEEN MODELS ARE AS FOLLOWS:

	C17	C18	C24	R21	R24	R25	R26	R27	R32	R33	R34	R41	R42
GT	.0015	.15	.033	18k	1M	68k	5.6k	30k	330k	13k	13k	JUMPER	13k
SE	470pF	.47	.022	3.3k	220k	100k	3.3k	33k	470k	75k	91k	4.7k	9.1k

NOT STUFFED IN GT: C10, C11, C12, C13, D1, D2, D3, R16, R17, R18, R19, R20, R29, W2, W3
 NOT STUFFED IN SE: C14, C15, C19, D5, D6, R22, R23, W1, W4, W5

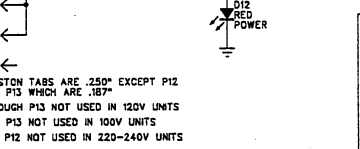
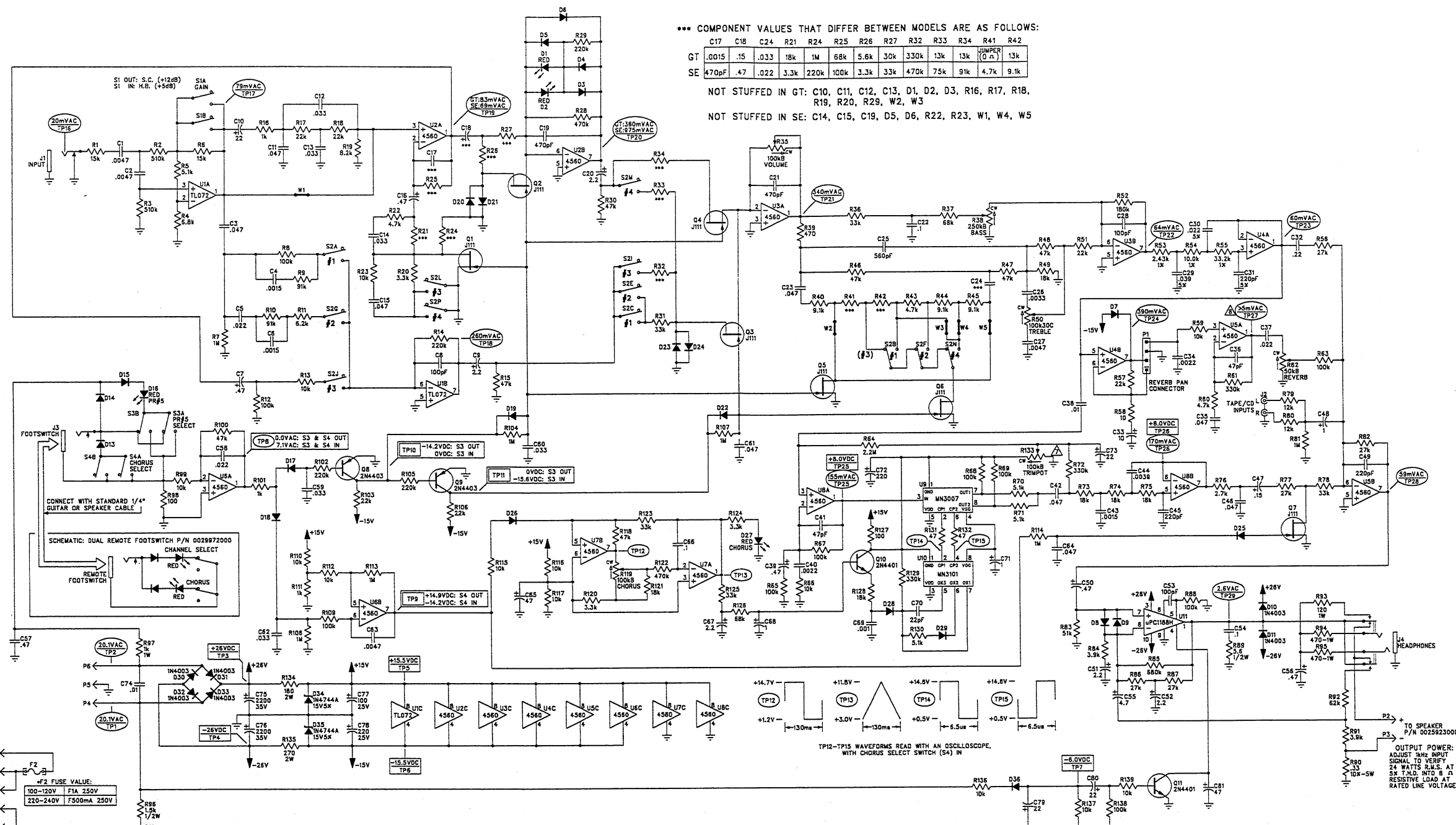

CONNECT WITH STANDARD 1/4" GUITAR OR SPEAKER CABLE



INTERLOCKING MECHANISM

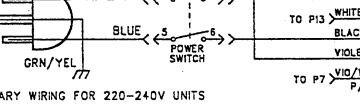

PRIMARY WIRING FOR 120V UNITS

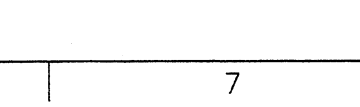

PRIMARY WIRING FOR 220-240V UNITS

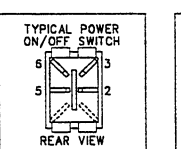

TYPICAL POWER ON/OFF SWITCH REAR VIEW

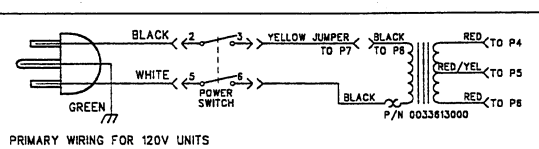

PRIMARY WIRING FOR 120V UNITS

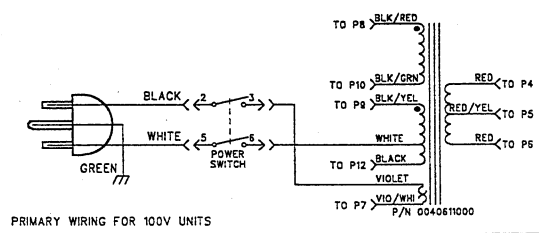

PRIMARY WIRING FOR 100V UNITS

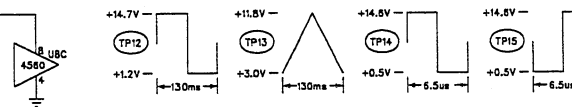

TP12-TP15 WAVEFORMS READ WITH AN OSCILLOSCOPE WITH CHORUS SELECT SWITCH (S4) IN

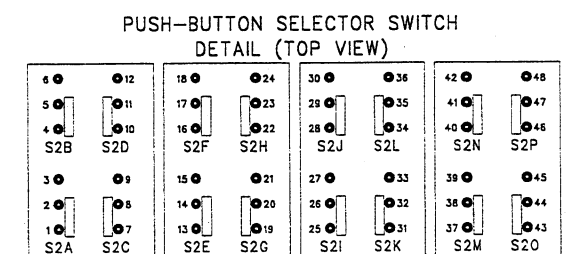

PUSH-BUTTON SELECTOR SWITCH DETAIL (TOP VIEW)

- LAST REFERENCE DESIGNATORS: C81, D36, F2, J4, P13, D11, R139, S4, TP28, U11, W5. (F1 NOT USED)
- TP27 CAN VARY FROM 5-500mVAC AND IS DEPENDENT UPON SPECIFIC EXCITATION FREQUENCY AND PARTICULAR REVERB PAN FREQUENCY RESPONSE.
- TO SET CHORUS BIAS, INCREASE 1kHz SINEWAVE INPUT TO ABOUT 200mV AND ADJUST TRIMPOT R133 TO SHOW SYMMETRICAL CLIPPING AT U8 PIN 7 (TP28).
- AC AND DC VOLTAGES READ TO GROUND WITH A DVM UNDER THE FOLLOWING CONDITIONS:
 UNIT AT RATED LINE VOLTAGE
 REVERB PAN P/N 0041387000 CONNECTED AT P1
 8 OHM RESISTIVE LOAD CONNECTED AT P2/P3
 CHORUS SELECT SWITCH (S4) IN OUT POSITION
 PRESET #1 SELECTED
 NO FOOTSWITCH CONNECTED
 "REVERB" CONTROL AT "0"
 "CHORUS" CONTROL AT "10"
 ALL OTHER CONTROLS AT "5"
 NO INPUT SIGNAL (TP1-TP15 ONLY)
- ADDITIONAL CONDITIONS FOR TP16-TP22:
 8 OHM RESISTIVE LOAD CONNECTED AT P2/P3
 PR25 SELECT SWITCH (S3) IN OUT POSITION
 CHORUS SELECT SWITCH (S4) IN OUT POSITION
- THIS SCHEMATIC IS FOR PCB FAB P/N 0051382000.
- ALL DIODES ARE 1N4448.
- ALL POLARIZED CAPACITORS IN uF; 50V (MIN.), 20X.
- ALL UNPOLARIZED CAPACITORS IN uF; 50V (MIN.), 10X OR BETTER.
- ALL RESISTORS IN OHMS; 1/4W, 5X.

NOTES: (UNLESS OTHERWISE NOTED)

THIS DOCUMENT CONTAINS INFORMATION OF A PROPRIETARY NATURE TO FENDER MUSICAL INSTRUMENTS AND IS SUBMITTED TO YOU IN CONFIDENCE AND SHALL NOT BE DISCLOSED OR TRANSMITTED TO OTHERS WITHOUT AUTHORIZATION FROM FENDER MUSICAL INSTRUMENTS.		FENDER MUSICAL INSTRUMENTS 2621 Research Drive Corona, CA 91720 USA	
CHECKED BY: B. DESI	APPROVED BY: B. DESI	TITLE: SCHEMATIC DIAGRAM, AUTOMATIC GT/SE AMPLIFIERS	REV. A
CK DATE: 13-MAY-97	AP DATE: 13-MAY-97	SIZE: D	DRAWING NUMBER: 0051623000
DRAWN: B. DESI	ENGR: B. DESI	RELEASE DATE: 16-MAY-97	SHEET: 1 OF 1